

LOW-E

REFLECTIVE INSULATION

Reduces your carbon footprint.



INSTALL GUIDE

CLASS A PRODUCTS



Installation ideas to help you install the ESP Low-E® product line and achieve maximum performance.

Table of Contents

Table of Contents	1
Product Specific Installations	2
Installation Cont.	3
Housewrap Applications	4
Pre Engineered Steel Applications	5
Post Frame Applications	6
Technical Specifications	7
Technical Specifications	8
Ceiling/Attic Applications	9
Roofing Applications	10
Basement/Blockwall -	11
Crawl Space - Floor Joists	11
Wall Applications	12
Other Important Information	13
Core Values/Mission Statement	14

Intent of this Manual

This manual is designed to assist you in understanding the R-Values that can be achieved with the installation of Low-E Insulation. A common misconception of reflective insulation is that one standard R-Value is applicable for every application. The following System R-Values you could achieve, are based on test data obtained under controlled conditions, computer calculations by Dr. David Yarbrough (Tennessee Technical University), or the ASHRAE Handbook of Fundamentals, using FTC guidelines. The system R-values in this booklet were calculated using tested results from ASTM C-236 or ASTM C-976 test methods and calculations from the ASHRAE Handbook of Fundamentals, as well as computer calculations. To properly apply the data in this manual to your specific application, we suggest you consult an engineer or architect.

While this information is presented in good faith and believed to be accurate, Environmentally Safe Products, Inc. and its distributors have no control over installation design, installation workmanship, accessories, materials or condition of application.

Environmentally Safe Products, Inc. does not guarantee results from reliance upon such information and disclaims any liability from any loss or damage arising from its uses.

AND THEN WE CREATED “ESP Low-E®” INSULATION

The primary function of Low-E insulation is to reduce the transfer of radiant energy. The materials that Low-E insulation is made from are polyethylene and aluminum. Our standard product consists of a micro-cell polyethylene core that will not absorb moisture, is very flexible and extremely strong. The exterior surfaces are covered with polished reinforced aluminum. Our patented Low-E insulation does have tested “R” values, but more importantly, it’s aluminum surfaces have an emissivity of .03, which equates to 97% of radiant heat is stopped and reflected back to their source.

Most common or conventional insulations do their best to slow down the heat transfer, but no matter how thick they are, they have limited ability to reflect radiant energy. In fact, they can act like a battery, storing heat, then re-radiating it. Mass insulations can also store moisture which further reduces their capabilities to resist the transfer of thermal energy. For these reasons, by mid afternoon in the summer, buildings using only mass type insulation can become unbearably hot. Even large air conditioning units battle against the odds all day and put a serious drain on utility companies not to mention your wallet.

By addressing only “R” values, manufacturers and consumers have ignored the major problem facing insulation today. You guessed it, ...radiant heat transfer. By using Low-E, you can reflect the heat back to the source. Therefore, buildings become more temperature consistent and more economical to operate, no matter what the season.

Core Values & Mission Statement

Core Values:

Glorify God in all we do
Respect for the individual
Strive for excellence
Create great value
Improve the human condition
Create fun and pleasure
Invent for the future
Put back into our communities

ESP is like a tree planted by streams of water, which yields its fruit in season and whose leaf does not wither. Whatever we do prospers. PS.1:3



Mission Statement:

We the People of Environmentally Safe Products will continue to provide growth to our Company, ensuring personal growth. This will be achieved by expanding our family worldwide, implementing new ideas with regards to products, while constantly striving for perfection within our existing facility. The customers' needs will always be our focus. We have the philosophy that service is the key to success. At ESP, Customer Service is not a department; it is an attitude! Every person that is involved in this company will continue to follow this philosophy and this will be passed down to every new person that joins us. One person alone can achieve great things. Many people united can achieve greatness. We will continue to work as a team from the executive ranks to the entry-level position. We will continue to promote from within allowing one to reach their personal goals. We will continue to prosper individually by helping the Company to prosper. We will never lose the drive and motivation that made this company the jewel that it is today. And we will take great pride in the sacrifices that we personally have made to create this masterpiece.

We began by coming together,
We have progressed by staying together,
We shall succeed by working together!

WE ARE Environmentally Safe Products!

Other Important Information

FLAMIBILITY TESTING & MANUFACTURER'S WARNING

All ESP Low-E Insulations have been tested in accordance with either the ASTM E-84 Surface Burning Characteristics for Building Materials or the NFPA 286 Full Scale Room Burn Test. The majority of ESP, Inc's Low-E Insulation product line meet the criteria in the Building Codes to be used in exposed building applications. Always consult your local building codes and officials before installing Low-E insulation if there is any questions concerning the building application. If there is any question concerning which product to use in your specific application, call 800-289-5693 and our representatives will be happy to assist you in choosing the correct product for your building. All products referred to in this manual are double sided foil products, either white aluminum or standard aluminum foil facings.

MANUFACTURER'S WARNING: It is not recommended that these products be left exposed in walls and ceilings where the ceiling height is less than 10 feet. If the product is to be installed in a building in the walls and ceiling with a ceiling height less than 10 feet, the wall should be covered with an approved thermal barrier (ex. gypsum board). Always consult your local building codes and officials before installing.

ASTM STANDARD TEST METHOD FOR SURFACE BURNING CHARACTERISTICS OF BUILDING MATERIALS:

This standard is used to measure and describe the response of materials, products, or assemblies to heat and flame under controlled laboratory conditions. ESP Low-E® products are tested within the strict standard of these test methods. This test method is not necessarily representative of the manner in which the ESP Low-E® products are installed in a typical field installation. The numerical ratings on all ESP Low-E® insulation products or any other materials are not intended to reflect hazards under actual fire conditions. ESP strives to have tests done as close as possible to the actual install methods.

Warning:

Aluminum is an Electrical Conductor. Please use caution when working around electrical sources including overhead power lines.

NOTE: Rolls of insulation shall be packaged in a polyethylene wrapping. Insulation shall be stored in a dry protected area. Do not allow insulation to come in contact with fresh concrete at any time. Any tears or punctures in the foil shall be repaired with aluminum tape. All seams that require taping must be taped with ESP approved tape.

Product Guarantee Warranty

Product Guarantee

Low-E Insulation products are guaranteed against defects in material and workmanship for 20 years. Blister or bubbles in product surface will not affect performance. Product thickness for products with foil on both sides may vary +/- 10%. All other products may vary +/- 20%.

Defective Material

The following criteria may be considered a defect; (1.) 1 inch wide or more of foil delamination on the edges for more than 15 feet of the roll. (2.) More than 1 inch of core showing on 20 feet or more of a roll. (3.) Large areas (more than 1 square foot) of delaminated foil.

Corrective Instructions

Occasionally there may be imperfections in product that may affect appearance but not performance. In the event this is encountered, the following solutions are advised; (1.) If there is core showing on one side, either tape the seam on that side when installed or install product with the core side in. (2.) If there is an edge that is delaminated, either tape the seam on that side when installed or install product with delaminated edge in. (3.) If there are areas that have a delamination that cannot be installed without correcting this defect, the following may be done with an iron; set the iron about half to three quarters temperature setting. Make a small slit with a razor knife in the center of the delamination and carefully, with light pressure, iron the foil towards the slit, allowing trapped air to escape. When finished, cover the slit with a small piece of Low-E tape.

Return Policy

(1.) It is our opinion that our Distributors should handle customer problems directly and ESP in turn will issue a credit or replace materials to the Distributor. The Distributor must make available to ESP a copy of the product label or the information on the label [lot#, initials, product description], samples of the defect, or the roll of material. Upon inspection of the defect, ESP will credit or replace defective material at ESP's discretion. If a section of a roll is bad, remove the bad area and use the rest of the roll. Retain the bad section and label information for credit. If label is not available, return the bad section. (2.) All labels on the product must be saved for verification. If label is not sent back with completely filled out complaint form, the complaint will not be acknowledged. If everything is in order on the complaint form and sheets and ESP requests the return of the roll, ESP will pay the shipping, however no material is to be returned without ESP approval. (3.) If the customer elects to keep all the product that is considered seconds, and the complaint forms and labels are sent back, ESP will credit the customer for the difference in first quality and second quality pricing. (4.) If the product is shipped out of the continental United States, the representative is totally responsible for all replacement costs and shipping charges of the material.

ABSOLUTELY NO SHIPPING CHARGES WILL BE ACCEPTED WITHOUT RETURN AUTHORIZATION FROM ESP

Disclaimer

R-values in this manual are achieved with ESP Low-E Products having foil facings with .03 emittance on both sides. Low-E products with a white foil facing will have a lower R-value. Please consult your manufacturer's representative for the thermal performance of these products.

Product Specific Install Instructions

An Air Space is Needed for Efficiency, Please Allow the Insulation to Sag in Your Roof System.

DO NOT PULL TIGHT!!

Wall Application: This material is designed to be installed from top to bottom, eave strut to the ground or rake angle to the ground, (perpendicular to the girts).

1. Start at one end of the wall you are about to sheet.
2. Make sure the material is square with the wall.
3. Using C-Clamps and a block of wood, secure the material to either the rake angle or eave strut.
4. Place double-sided adhesive tape around entire bottom perimeter of the building on the outside of the metal plate. Steadily, unroll the material to the ground, adjust roll so seams line up evenly then secure the bottom of the roll to the double-sided adhesive tape.
5. Go back to the top of the wall.
6. Repeat steps 2 and 3.

If Product has the Staple Flange Edge:

7. Bring the core edges tightly together with both flanges (no core in them) towards you.
8. Roll both flanges together securely keeping core edges tightly together.
9. Staple the flanges close to the core with a heavy-duty plier stapler every 2-3 inches.
10. Then put closure strips over insulation and cut off excess.
11. Be sure to leave enough overlap to insure that the material will not pull apart after panels are installed.
12. Repeat steps 5 thru 11 until you complete the area to be insulated.



If Product has the EZ-Seal Edge:

7. Fold back the insulated tab on the leading edge of the run you just finished.
8. Fold back the insulated tab on the trailing edge of the run you are about to install. It will contain double-sided adhesive tape.
9. Butt the folded edge of the new run tightly against the folded edge of the run, which is already in place.
10. Repeat steps 2 and 3.
11. Peel off the release paper from the double-sided adhesive tape.



IF THE TAPE ISN'T STICKING BECAUSE OF MOISTURE IN THE AIR STAPLE EVERY 2-3 INCHES AND DON'T USE THE TAPE TAB TO SEAL THE EDGE.

12. Press the two insulated tabs tightly together making certain they are even. Place your thumb and fingers in the groove and use as a guide as you work down the wall NOTE. For best appearance and easiest installation it is advisable to complete the process in steps 10 & 11 a foot or so at a time as you unroll down the wall.
13. Using a heavy-duty plier stapler, staple taped seam every 6 – 12 inches.
14. Steadily unroll the run down the wall, about a foot or so at a time, continue using the process described in steps 10 and 11.
15. Then put closure strips over insulation and cut off excess.
16. Be sure to leave enough overlap to insure that the material will not pull apart after panels are installed.
17. Repeat steps 5 thru 16 until you complete the area to be insulated

If Product has Trimmed Edge:

7. Butt the edges of the insulation together.
8. Starting at one end of the edges, pull the paper backing off of the tape to apply the seam tape.
9. While applying the seam tape use the plastic squeegee (provided for you) to bond the insulation and the seam tape together. This is done by taking the plastic squeegee and firmly pressing down, running it the length of the tape. If done correctly, you will see that the seam tape blends in with the insulation. (If the squeegee is not used, the seam tape will not adhere itself to the insulation and the seams will possibly come loose over time.)
10. Apply small sections at a time, making sure that you are bonding the seam tape to the insulation.
11. Once you reach the end of your length, use a razor knife or a pair of scissors to cut the seam tape. Tearing the tape may stretch it and the adhesive; this puts an undue strain on the tape and will hamper its performance.
12. Place closure strips over the insulation
13. Repeat steps 5 thru 11 until you complete the area to be insulated

Install Instructions Cont.

Installation Instructions Cont.

Roof Application: Start by using a double-sided adhesive tape around the roof perimeter or fold a small section of the material back over itself and secure to the eave with a fastener every 6-12 inches. *It is important to have an airspace between the roof decking and the Low-E. This is achieved by draping the Low-E, allowing it to sag approx. ¾"-1".*

NOTE: If any defective or damaged material is encountered simply cut out the bad section and splice the remaining material together.

All splices made on wall sections must be placed behind the girts. This will conceal the splices and help to maintain a completely uniform appearance.

To do this, go to the girts immediately above and below the defective or damaged material and cut out from these lines. This will allow you to make your splice behind the girt.

Seams that are exposed to conditioned space must be taped with Low-E Seam tape. This product should not be left exposed in a ceiling that is 10' high or less. Consult your local building/fire codes to ensure that the proper material is used if this situation does occur. This product should not be overlapped. Never interfere with the design ventilation of the building when installing any form of insulation. Never expose any insulation to any fire source. Insulation shall be stored in a protected area. Do not let insulation come in contact with wet or damp concrete at any time. Any tears or punctures in the insulation shall be repaired by the appropriate Low-E Seam tape.

Splicing Low-E insulation:

Place double sided tape on last purlin covered by Low-E insulation to secure end. Trim end where it is concealed by purlin. Place double sided tape on the top of the Low-E insulation and lay new section of the top of the existing one. Procedure for making a splice: 1. Cut a piece from another roll a little larger than the area to be removed. Overlay the ends of the two pieces to be spliced together. 2. Cut through the two pieces using a straight edge, to create a common edge. 3. Butt the two edges tight together. 4. Tape the seam on both sides using the manufacturer provided aluminum seam tape. **WHEN APPLYING LOW-E SEAM TAPE BE SURE TO CUT THE TAPE. DO NOT RIP OR TEAR. RIPPING OR TEARING CAN NEGATIVELY AFFECT THE ADHESIVE. WHEN APPLYING LOW-E SEAM TAPE, BE SURE TO USE THE MANUFACTURER SUPPLIED SQUEEGEE TO ENSURE THE TAPE IS PROPERLY ADHERED. WHEN USING TAPE TO MAKE REPAIRS RUN TAPE PARALLEL WITH THE INSULATION. ***NEVER RUN TAPE AT AN ANGLE.** NOTE: LOW-E seam tape can also be used as a patch material to cover up and repair any cracks or tears in the LOW-E. Please refer to the above instructions for the application of LOW-E seam tape. NOTE: When installing above a framed opening i.e. (a dock door) be sure to wrap the material around the door header to the inside of the building. The door installers can then trim any excess LOW-E out of the way. This procedure will ensure that there will not be a gap in the insulation after the door is installed.

NOTE: If any defective or damaged material is encountered simply cut out the bad section and splice the remaining material together. Local building codes shall be followed to ensure proper installation. The thermal performance of Low-E Insulation in these installations are based on the maintenance of a totally enclosed air space adjacent to the low emittance surface(s). Thermal values for this product are defined by typical installations and are obtained in accordance to accepted test methods and are subject to manufacturing variations. They are supplied as a technical service and are subject to change without notice. These products should never have a core edge exposed. Seams that are exposed to conditioned space must be taped with Low-E Seam tape. No insulation products should be left exposed in a ceiling that is 10' high or less. Add Gypsum board or another type of fire wall. Consult your local building/fire codes to ensure that the proper material is used if this situation does occur. These products should not be overlapped. Never interfere with the design ventilation of the building when installing any form of insulation. Never expose any insulation to any fire source. Insulation shall be stored in a protected area. Do not let insulation come in contact with wet or damp concrete at any time.

****IT IS EXTREMELY IMPORTANT TO LINE THE SEAMS UP STRAIGHT IN ALL APPLICATIONS BEFORE YOU SECURE THE INSULATION.**

PLEASE DO NOT WALK ON INSULATION WHEN IT IS CUT BEFORE INSTALLATION.

These products should never have a core edge exposed. Seams that are exposed to conditioned space must be taped with Low-E Seam tape.

Wall Applications

Wall Application with Low-E & Mass Insulation (2 x 4) & (2 x 6)

System R-Value: R-18.91, Horizontal Heatflow Only

The first step in this application is to install mass insulation in the wall cavity. Next install Low-E Insulation Tab Material with the tab flush to the outside of the stud. It is recommended that 1/2" staples be applied approximately every 6" along tab to fasten Low-E. All seams are taped securely with Low-E Tape. Cover the face of each stud with tape. All seams around electrical boxes are taped. For 2x6 installation, follow above instructions but add wire supports to provide additional air space between the Low-E insulation and the mass insulation. Due to compression R-value may be slightly lower.

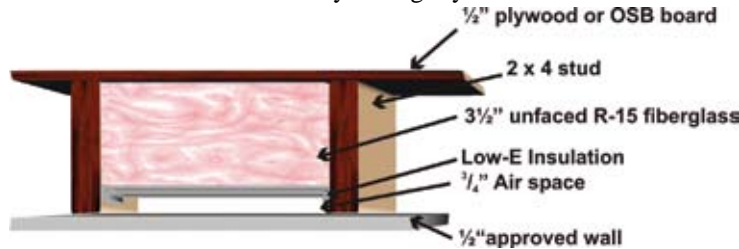

System R-Value: R-22.75, Horizontal Heatflow Only

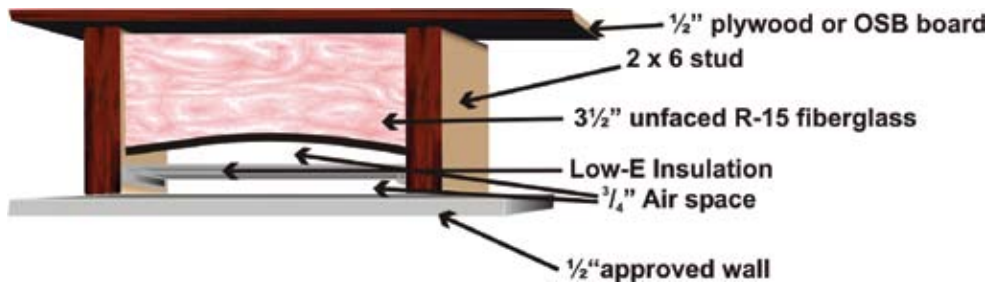

THE SYSTEM R-VALUES FOR THESE INSTALLATION METHODS WERE CALCULATED USING DATA FROM THE 1989 ASHRAE HANDBOOK OF FUNDAMENTALS.

Wall Application with 1 Layer of Low-E (No Mass Insulation)

System R-Value: R-9.06, Horizontal Heatflow Only

Install Low-E Insulation Tab Material with the tab centered within the stud cavity. It is recommended that 1/2" staples be applied approximately every 6" along tab to fasten Low-E. All seams are taped securely with Low-E Tape. All seams around electrical boxes are taped. To achieve a vapor retarder, all seams must be taped securely with Low-E tape.

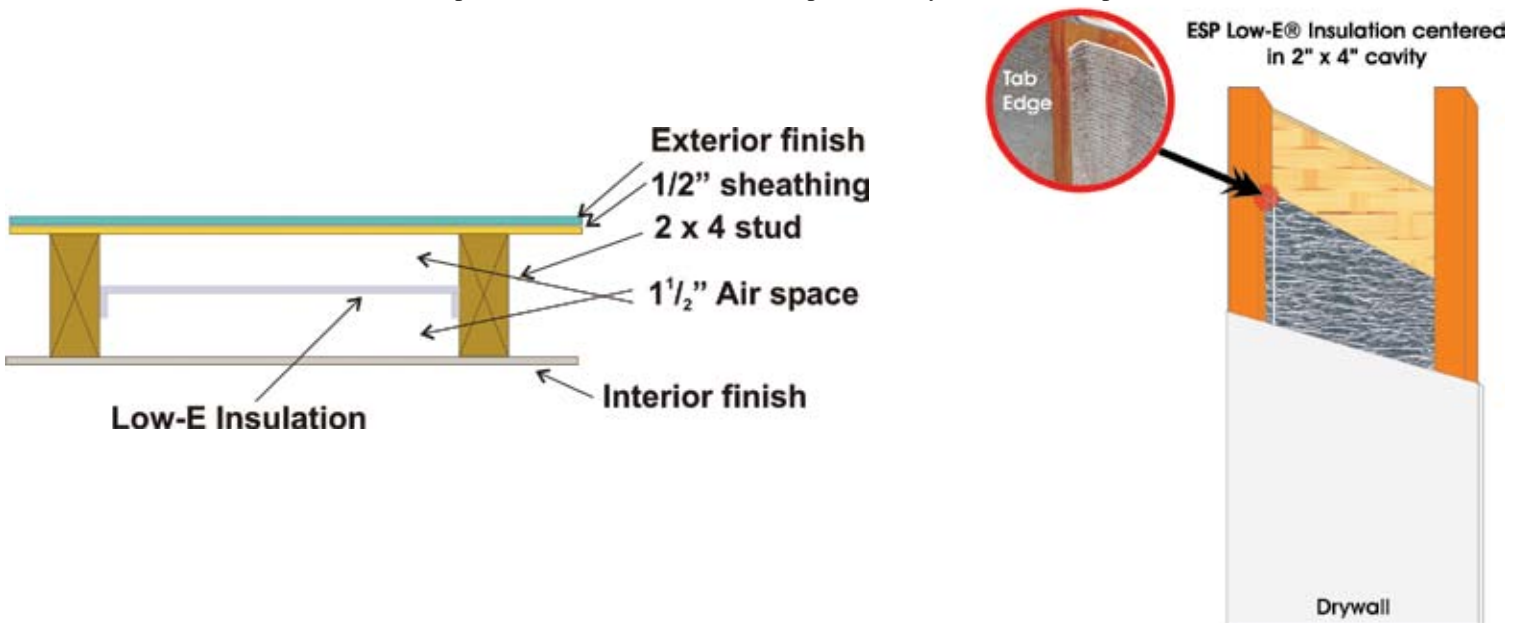

CALCULATIONS FOR THIS ASSEMBLY WERE DONE BY R&D SERVICES REPORT NUMBER RD03224.

Basement/Block Wall - Crawl Space - Floor Joist Applications

Basement Wall Applications

***1 System R-Value: R-5.7 Horizontal Heat Flow Only**

System R-Value: R-8.12 Horizontal Heat Flow Only

Please note that these are two different applications with different R-values. Measure wall area to determine square footage of Low-E Insulation required (length x height). Roll out material and fasten as per diagram with 1/2" staples approximately every 6". To achieve a vapor retarder all seams and stud faces must be taped securely with Low-E tape.

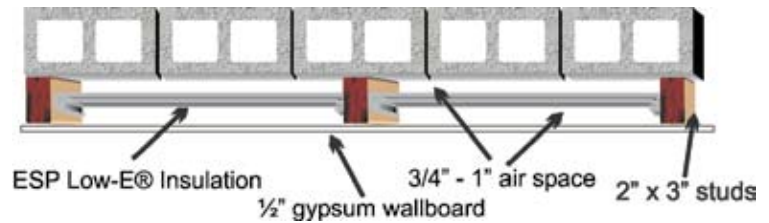
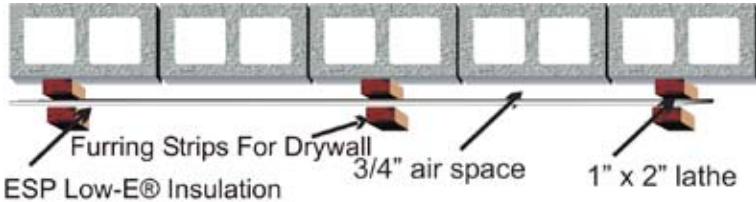

*1 - SYSTEM R-VALUES FOR HORIZONTAL HEAT FLOW, WITH ONE ENCLOSED AIR SPACE, INCLUDE AND ADDITIONAL 1.70 STILL AIR FILM FOR EXPOSED SIDE OF ESP LOW-E®.

Crawl Space Applications

***2 System R-Value: R-20 Downward Heat Flow Only**

Low-E can be used under your floor in a crawlspace to stop any air infiltration and add high insulating value to your floors. In a crawlspace application Low-E can achieve as high as an R-20. Low-E will not mold, mildew or absorb moisture, so once it's installed there is virtually no maintenance involved. In areas where flooding is a problem Low-E will eliminate the concern of your insulation system performing below average.

This Installation is for basement / crawlspaces with a 2" x 8" joist minimum. Low-E Insulation is installed across the bottom face of the joist. ALL R-VALUES ARE SYSTEM R-VALUES. AN ENCLOSED AIR SPACE MUST BE MAINTAINED TO ACHIEVE THESE VALUES. IF THE BOTTOM SURFACE OF THE LOW-E INSULATION MUST BE COVERED BY ANOTHER SURFACE, R-VALUE MAY BE LOWER.

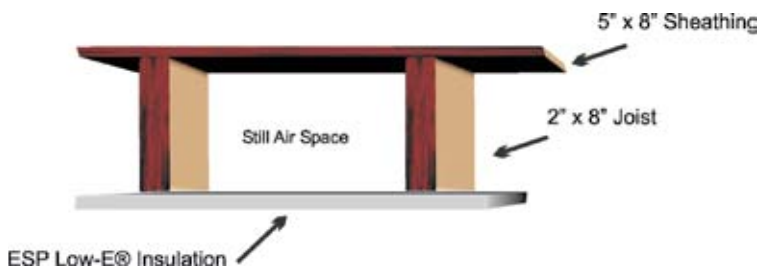

Measure entire joist area to determine square footage of Low-E Insulation required (length x width). Roll out material and fasten to bottom of floor joist with 1/2" staples every 6". To achieve a vapor retarder, all seams must be taped securely with Low-E tape.

*2 SYSTEM R-VALUES FOR HEAT FLOW DOWN, WITH ONE ENCLOSED AIRSPACE, INCLUDE AND ADDITIONAL 4.55 STILL AIR FILM FOR EXPOSED SIDE OF ESP LOW-E® INSULATION.

Floor Joist Applications

System R-Value: R-20.20, Downward Heat Flow Only

Measure entire joist area to determine square footage of Low-E Insulation required (length x width). We recommend Low-E 16" or 24" tab material. Roll out material and fasten to inside of floor joist in the center of the cavity by stapling 3/4" tabs as per diagram to right with 1/2" staple every 6". To achieve a vapor retarder, all seams must be taped securely with Low-E tape.

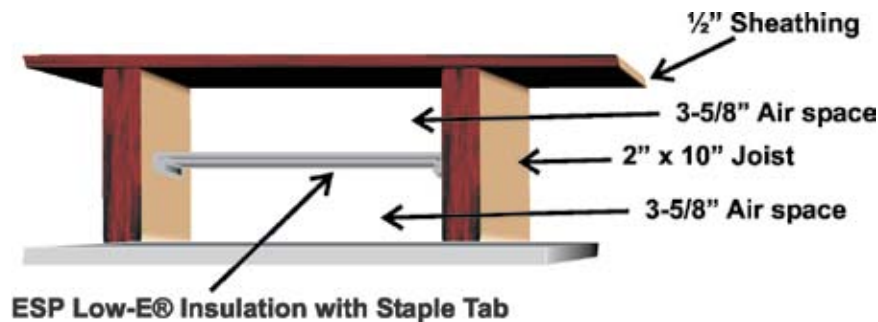

HouseWrap Applications

Housewrap Applications

System R-Value: R-4.17 Horizontal Heat Flow Only

Installation Method (Existing Walls)

1. Make sure reflective side faces out.
2. If product has foil flange make sure foil flange side of roll faces down. (5' has no flange, only use on bottom run)
3. Starting at the corner of the preferred exterior wall unroll Low-E Housewrap™ in a horizontal manner using staples or cap nails to attach to exterior sheathing every 8" to 12".
4. Roll Low-E Housewrap™ over door and window openings. (see pg. 6 for framed opening instructions)
5. The bottom side of the Low-E Housewrap™ should extend over sill plate by 3" to 4".
6. When applying second horizontal run of Low-E Housewrap™ butt foam ends together allowing foil flange to overlap 2". Make certain foil flange is to the outside to ensure water drainage plane downward.
7. Tape all vertical and horizontal flange seam areas with approved Low-E foil tape.
8. Continue method until Low-E Housewrap™ covers both top plates.
9. Use Low-E foil tape to repair areas that have been torn or compromised.
10. Foil is a conductor of electricity. Use extreme caution when working with Low-E Housewrap™ around power lines, wiring and electrical devices.

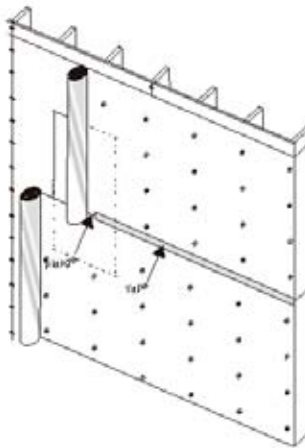

1. When coming to the end of existing roll in use, leave up to 12 inches of product unattached to wall system.
2. Remove new roll from packaging
3. Unroll Low-E Housewrap™ to desired area making sure that product is plumb and square with housewrap already in place and also overlap material past the end of previous material by approx 8 inches.
4. Locate center of overlapped materials and make common splice through both layers of material using utility knife.
5. Remove cut material from end of previous roll and start of new roll
6. Apply Low-E Tape over common splice, then continue installing Low-E Housewrap™ as described in Figure 1

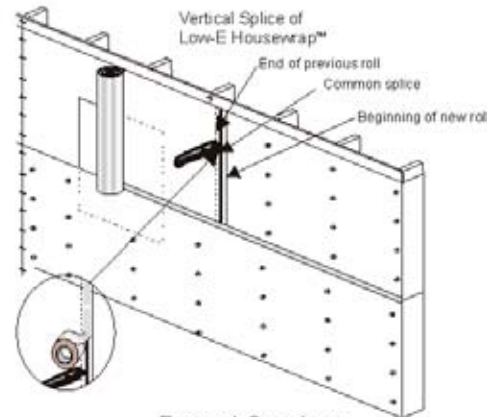

Penetration Installation Diagrams

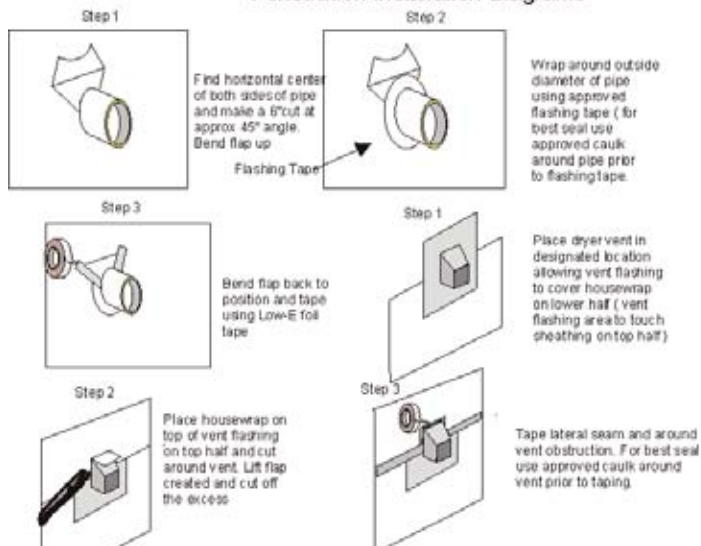

Tears and Holes Repair

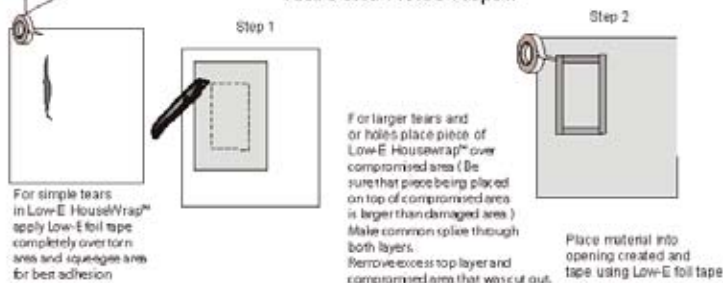

Framed Openings

When installing Low-E Housewrap™ over the exterior of structure be sure to run product horizontally over entire wall including framed openings. (Please refer to page 5 for more detailed instructions)

Once Low-E Housewrap™ has been securely fastened to exterior sheathing make cuts as shown in Figure 2. Try not to cut past exterior side of framed opening (exception for top of framed opening but in the event that occurs use Low-E foil tape to repair area that was compromised).

1. An additional flap should be cut above the top exterior side of framed opening for the installation of head flashing.
2. Bend flap away from wall to allow installation of window and flashing.
3. Apply window and head flashing.
4. Reset Low-E Housewrap™ and tape seams.

Once side and bottom flaps have been cut, bend these flaps toward the interior of structure using staples.

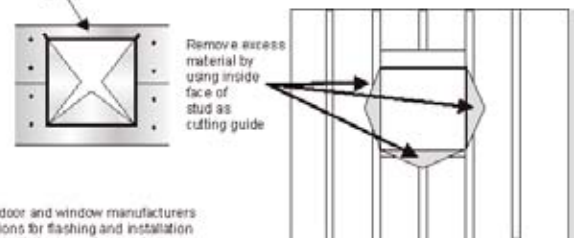

SYSTEM R-VALUES CALCULATIONS FOR THIS ASSEMBLY WERE PERFORMED BY R&D SERVICES REPORT NUMBER RD03224.

Pre Engineered Steel Applications

Commercial Metal Roofing

Average System R-value: Down R-11.04, Up R-7.39

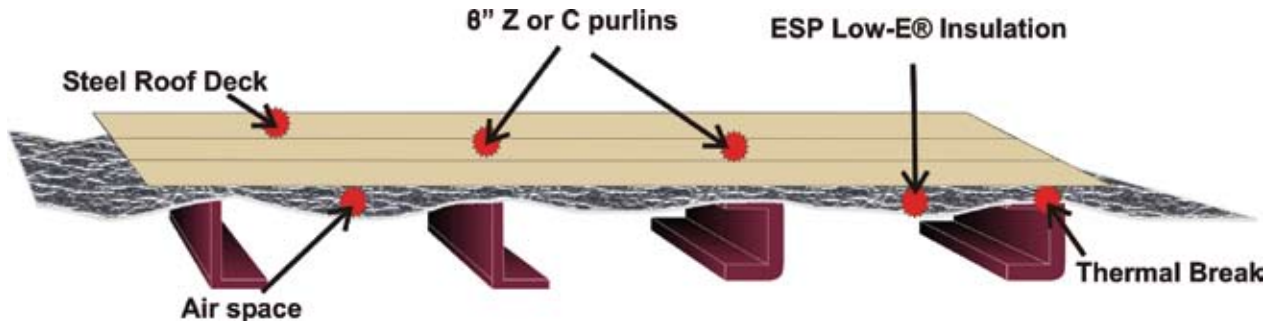

Average System R-value: Down R-21.04 (3" Fiberglass), Down R-30.04 (6" Fiberglass)
Up R-17.39 (3" Fiberglass), Up R-26.39 (6" Fiberglass)

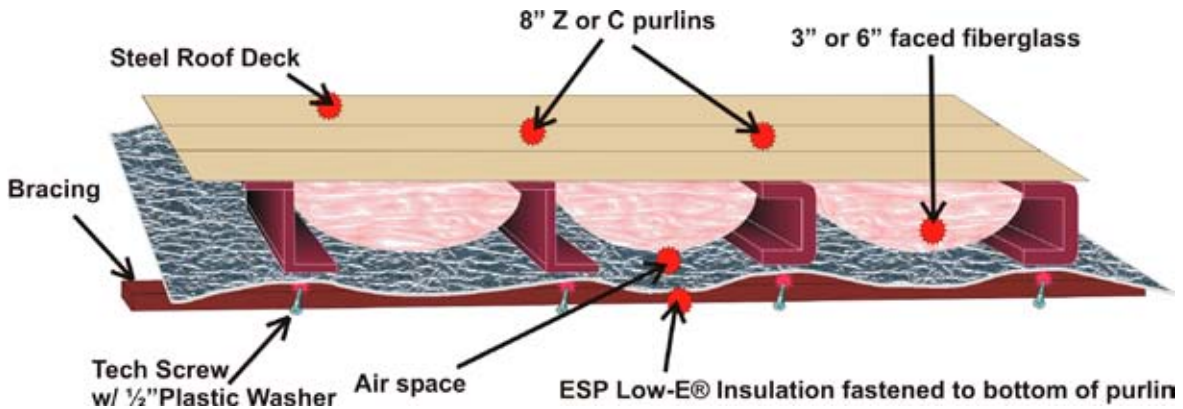

THE SYSTEM R-VALUES FOR ESP LOW-E® INSULATION AS PER ASTM C-976, AIR TO AIR, ADJUSTED TO MEET CRITERIA EQUIVALENT TO ASTM 1224.

ASHRAE 90.1 Compliance Application

Average System R-value: R-17.85 (3" Fiberglass) *SDR, R-21.73 (3" Fiberglass) *SSR, R-18.51 (4" Fiberglass) *SDR
R-26.31 (6" Fiberglass) *SSR, R-30.30 (6" + 3" Fiberglass) *SSR, * SDR = Screw Down Roof * SSR = Standing Seam Roof

ESP Low-E® Insulation and ASHRAE 90.1 System Patent Pending

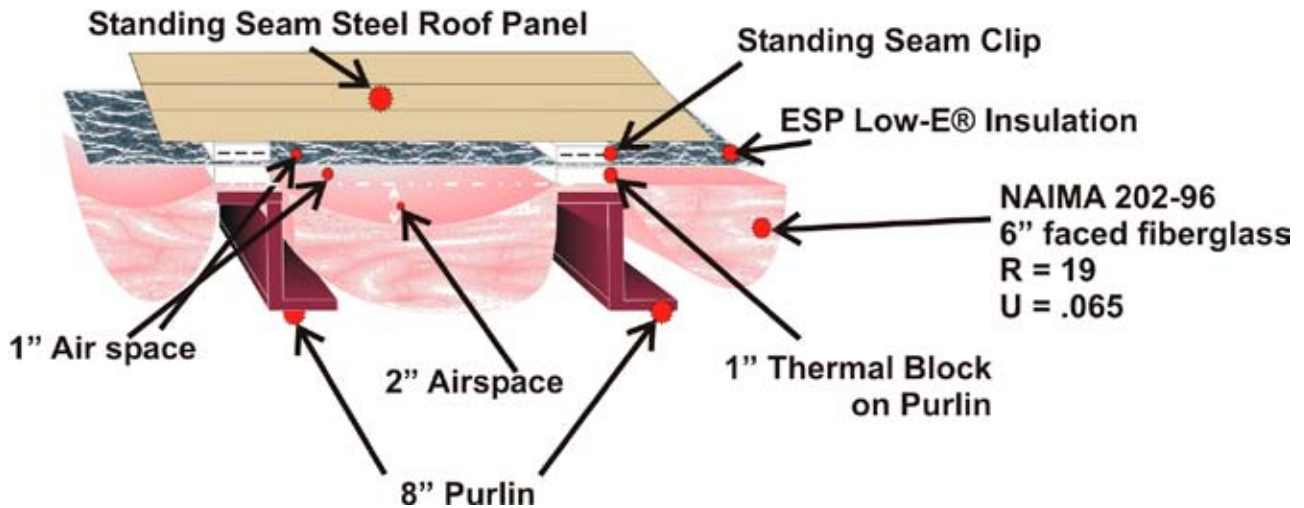

THE SYSTEM R-VALUES CALCULATED USING ENVSTD 4.0 USING ESP LOW-E® INSULATION AS R-LL SHEATHING.

Roofing Applications

“New Construction” Over Roof Rafter Installation

Average System R-value: Down R-11.04, Up R-7.39

After roof truss or roof rafters have been located and installed, install Low-E Insulation® by drooping approx. 2” at center of span over the truss/rafters. Use staples to attach material. Rolls of insulation should be taped to properly seam the material to assure a proper vapor barrier. If continuous roof/ridge vent is to be installed, insulation should stop approx. 2” from vent to allow flow of air out of roof system.

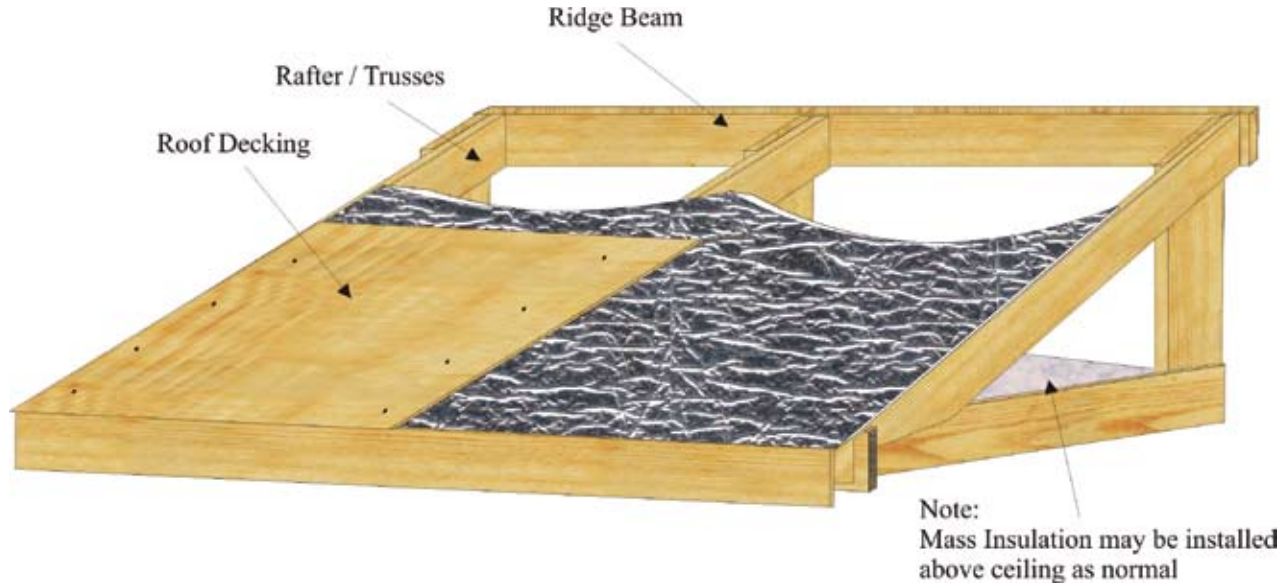

THE SYSTEM R-VALUES FOR ESP LOW-E® INSULATION AS PER ASTM C-976, AIR TO AIR, ADJUSTED TO MEET CRITERIA EQUIVALENT TO ASTM 1224.

Residential Metal Roof Install

Average System R-value: Down R-9.15

Furring boards provide airspace between top of ESP Low-E® Insulation and underside of metal roof.

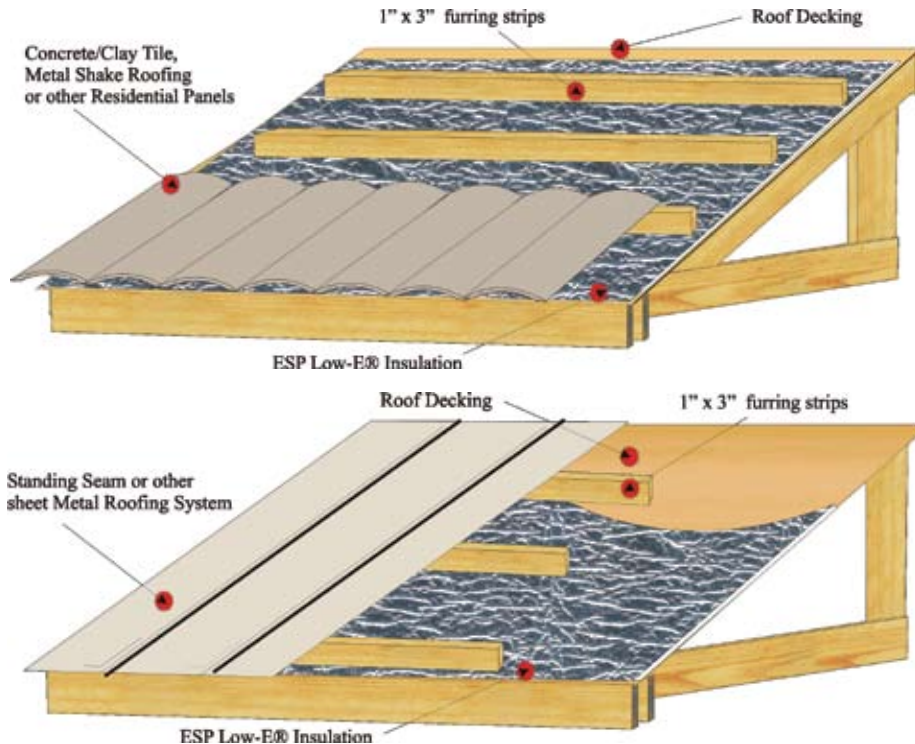

THE SYSTEM R-VALUES FOR THESE INSTALLATION METHODS WERE CALCULATED USING DATA FROM THE 1989 ASHRAE HANDBOOK OF FUNDAMENTALS.

Ceiling Applications

Ceiling Application with Low-E & Blown In Insulation

System R-Value R-34.70 Downward Heat Flow, System R-Value R-33.75 Upward Heat Flow

Measure entire ceiling joist area to determine square footage of Low-E Insulation required (length x width). Roll out material and fasten to bottom of ceiling joist, stapling with 1/2" staples every 6". To achieve a vapor retarder, all adjoining seams must be taped securely with Low-E tape. Secure lathe strips and interior ceiling using approved application methods.

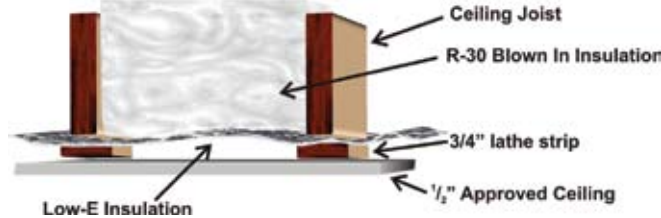

Recessed Ceiling Application with Low-E & Blown In Insulation

System R-Value: R-38.04 Downward Heat Flow, System R-Value R-32.87 Upward Heat Flow

Measure entire ceiling joist area to determine square footage of Low-E Insulation required (length x width). We recommend using Low-E Insulation with tabs. Roll out tab material and fasten by recessing it 1-1/2" into ceiling joist cavity, stapling with 1/2" staples every 6". To achieve a vapor retarder, all adjoining seams must be taped securely with Low-E tape. Secure interior ceiling using approved application methods.

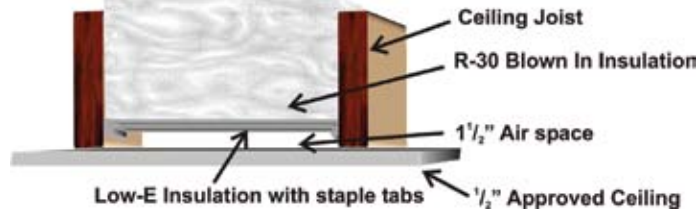

THE SYSTEM R-VALUES FOR THESE INSTALLATION METHODS WERE CALCULATED USING DATA FROM THE 1989 ASHRAE HANDBOOK OF FUNDAMENTALS.

Suggested Cathedral Ceiling Installation

System R-Value: Downward Heat Flow R-29.74, Upward Heat Flow R-26.55

Install 24" ESP Low-E® Tab Insulation as the baffling under wood deck to insure proper ventilation. Install fiberglass according to manufacturers recommendation.

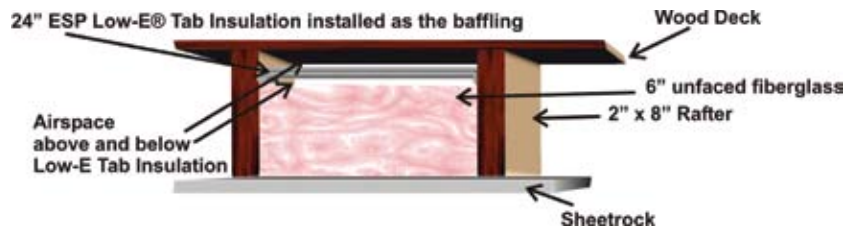

THE SYSTEM R-VALUES FOR ESP LOW-E® INSULATION AS PER ASTM C-236, AIR TO AIR, ADJUSTED TO MEET CRITERIA EQUIVALENT TO ASTM 1224.

Attic Rafters/Attic Blanket

This installation below is for retrofitting rafters as an energy upgrade. Low-E Insulation is installed across the bottom face of the rafter. Proper ventilation must be maintained. Measure rafter area to determine square footage of Low-E Insulation required (length x width). Roll out material and fasten to bottom of rafter face with 1/2" staples approximately every 6 inches. We suggest starting at the peak and working down to the eave. Leave approximately 1/2" space at the peak for ventilation. All adjoining seams must be taped securely with Low-E tape, unless a staple flange product is used.



Low-E Attic Blanket is perfect for going right over your ceiling joists. The product is pin perforated to allow moisture to escape.

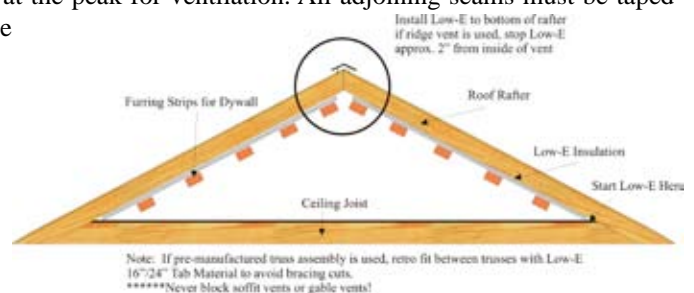

Post Frame Applications

Post Frame Roof Application

Average System R-value: Down R-11.04, Up R-7.39

When installing Low-E Insulation in post frame buildings, it is important to have an air space between the metal roof panel and the Low-E. This is best achieved by draping Low-E over the purlins from eave to eave, allowing it to sag approximately 3/4" to 1" between the purlins. After the first 4' run is tack fastened (3 1/2" staples /purlin), install the first section of roof sheeting and work from that to make the next run of Low-E and so on for the length of the building. It is important that all seams be securely taped with Low-E tape unless a staple flanged product is used.

If the building has a ridge vent, cut the Low-E loose at the peak before installing the vent.

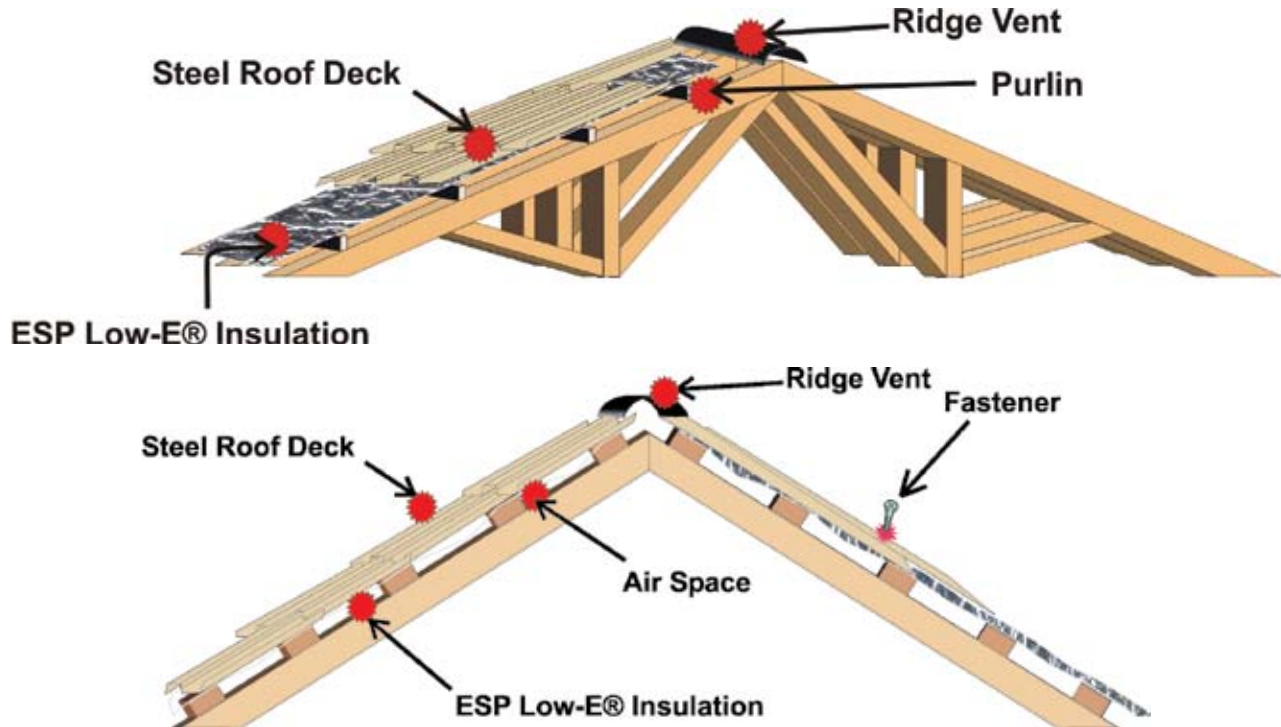

Post Frame Wall Application

Average System R-value: Horizontal R-8.55

Wrap Low-E Insulation around outside of framework, temporarily tack fasten Low-E loosely to outside of each girt with 1/2" staples allowing Low-E to bow in approximately 3/4" creating an enclosed air space. To achieve a vapor retarder all adjoining seams must be securely taped using Low-E tape unless a staple flanged product is used. Then attach metal siding by approved method.

Post Frame Wall Application

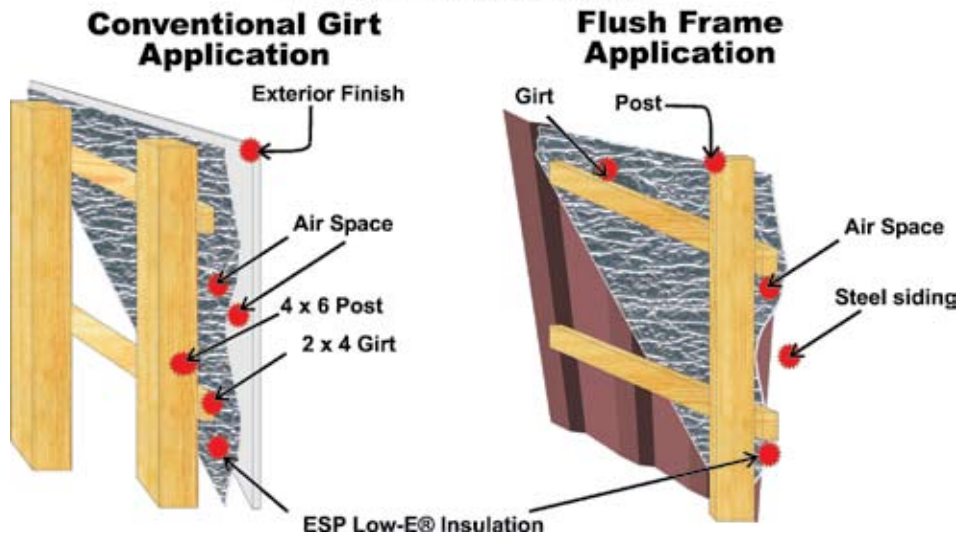

Technical Specifications

ESP Code	R-VALUE: ASTM C-976 ASTM C-236, DOWN HORIZONTAL, UP	NFPA 286 Fire Test	R-VALUE: ASTM 518DOWN, HORIZONTAL	FIRE RATING ASTM E-84 2" HEX. WIRE MESH WITH RODS 2' O.C. ¹	FIRE RAT NO HEX WITH R
DOUBLE SIDED NON-SCRIMMED FOIL EZ-SEAL LAMINATED					
4EFEZ ⁶	D-10.74, H-7.75, U-7.55			Class A, Class 1	Class
DOUBLE SIDED NON-SCRIMMED FOIL STAPLE/FLANGE LAMINATED					
4EFES ⁶	D-10.74, H-7.75, U-7.55			Class A, Class 1	Class
DOUBLE SIDED SCRIMMED FOIL STAPLE/FLANGE LAMINATED					
4LFLS ⁶	D-10.74, H-7.75, U-7.55	PASSED****		Class A, Class 1	
CLASS A WHITE EZ-SEAL LAMINATED (WHITE FACE E					
4EFWZ ⁶	D-8.33, H-7.00, U-6.14	PASSED****		Class A, Class 1	
CLASS A WHITE STAPLE/FLANGE LAMINATED (WHITE FACE E					
4EFWS	D-8.33, H-7.00, U-6.14	PASSED****		Class A, Class 1	
DOUBLE SIDED SCRIMMED FOIL TRIMMED EDGE LAMINATED					
4LFLT ⁶	D-10.74, H-7.75, U-7.55	PASSED****		Class A, Class 1	
DOUBLE SIDED NON-SCRIMMED FOIL TRIMMED EDGE LAMINATED					
4EFED ^{5,6}	N/T		D-6.41, H-6.71 ⁴	Class A, Class 1	Class
16EFEC	D-10.74, H-7.75, U-7.55			Class A, Class 1	Class
18EFEC	D-10.74, H-7.75, U-7.55			Class A, Class 1	Class
24EFEC	D-10.74, H-7.75, U-7.55			Class A, Class 1	Class
4EFET	D-10.74, H-7.75, U-7.55			Class A, Class 1	Class
4EMET	D-10.24, H-7.05, U-7.25 ²			Class A, Class 1	
NON-SCRIMMED (PERFORATED) HOUSEWRAP LAMINATED					
4PMNT ⁵	WALL R-4.17 ³			Class A, Class 1	

ALL R-VALUES ARE PUBLISHED AIR TO AIR AND DO NOT INCLUDE ANY ADDITIONAL AIR FILMS

¹ TESTING INSULATION PRODUCTS WITH SUPPORTS IS WITHIN THE SCOPE OF THE ASTM E-84 STANDARD TEST METHOD.

THIS TEST METHOD IS NOT ADOPTED AND ANSI APPROVED. www.astm.org

IT IS ALSO ACCEPTED BY ICC, MIAMI DADE, DADE COUNTY PUBLIC SCHOOLS AND THE WI DEPARTMENT OF COMMERCE MATERIAL APPROVAL.

MIAMI-DADE COUNTY PRODUCT CONTROL APPROVED, DRAWING NO.D-IIO2020307

DADE COUNTY PUBLIC SCHOOLS: APPROVED

WISCONSIN MATERIAL APPROVAL 970086-I

² THIS IS A CALCULATED R-VALUE BASED ON THE 1/4" RESULTS ADJUSTED FOR THICKNESS OF CORE

³ SYSTEM R-VALUES PER ASTM C-976, AIR TO AIR R-6.75 LESS R-2.58 FOR 1.5" AIR SPACE LOSS FOR FLUSH FIT AGAINST SHEATHING

⁴ SYSTEM R-VALUES AS PER ASTM C-518 WITH .5" AIRSPACE

⁵ THIS PRODUCT AVAILABLE IN 5' WIDTHS

⁶ THIS PRODUCT AVAILABLE IN 6' WIDTHS

⁷ FULL SYSTEM R-VALUES AS PER ASTM C-518 WITH CONCRETE ASSEMBLY

MANUFACTURER WARNING:

DO NOT LEAVE THIS PRODUCT EXPOSED ON WALLS OR CEILINGS WHERE CEILINGS ARE UNDER 10'.

AREAS UNDER 10' SHOULD BE COVERED WITH A PROPER THERMAL BARRIER.



Technical Specifications

TESTING ASTM E-84 WIRE MESH RODS 2' O.C. ¹	FIRE RATING ASTM E-84 NO HEX. WIRE MESH NO RODS UNSUPPORTED	PERM RATING ASTM E-96	DOT FMVSS 302	FUNGI TEST ASTM C-1338	ICC ESR-1261 WALL CAVITY	PUNCTURE RESISTANCE T-803-99	TOXIC OR HAZARDOUS INGREDIENTS
Class A, Class 1	N/T	0.008	N/T	PASSED	N/T		NONE
Class A, Class 1	N/T	0.008	N/T	PASSED	N/T		NONE
N/T	Class A, Class 1	0.008	PASSED	PASSED	N/T	39.9 PSI	NONE
(EXPOSED TO FLAME)							
N/T	N/T	0.008	N/T	PASSED	N/T		NONE
(EXPOSED TO FLAME)							
N/T	N/T	0.008	N/T	PASSED	N/T		NONE
N/T	Class A, Class 1	0.008	PASSED	PASSED	N/T	39.9 PSI	NONE
Class A, Class 1	N/T	0.008	PASSED	PASSED	APPROVED	39.9 PSI	NONE
Class A, Class 1	N/T	0.008	PASSED	PASSED	APPROVED	39.9 PSI	NONE
Class A, Class 1	N/T	0.008	PASSED	PASSED	APPROVED	39.9 PSI	NONE
Class A, Class 1	N/T	0.008	N/T	N/T	N/T		NONE
N/T	N/T	0.008	N/T	N/T	N/T		NONE
N/T	N/T	4.65	N/T	N/T	N/T		NONE

ASTM E-84 STANDARD TEST METHOD FOR SURFACE BURNING CHARACTERISTICS OF BUILDING MATERIALS: THIS STANDARD IS USED TO MEASURE AND DESCRIBE THE RESPONSE OF MATERIALS, PRODUCTS OR ASSEMBLIES TO HEAT AND FLAME UNDER CONTROLLED LABORATORY CONDITIONS. LOW-E INSULATION PRODUCTS ARE TESTED WITHIN THE STRICT STANDARD OF THIS TEST METHOD. THIS TEST METHOD IS NOT NECESSARILY REPRESENTATIVE OF THE MANNER IN WHICH THE LOW-E INSULATION PRODUCTS ARE INSTALLED IN A TYPICAL FIELD INSTALLATION. THE NUMERICAL FLAME SPREAD AND SMOKE DEVELOPED RATINGS ON ALL LOW-E INSULATION PRODUCTS OR ANY OTHER MATERIALS ARE NOT INTENDED TO REFLECT HAZARDS UNDER ACTUAL FIRE CONDITIONS. TO ACHIEVE A CLASS A CLASS 1 RATING FOR THE ASTM E-84 TEST, A MATERIAL MUST HAVE A FLAME SPREAD INDEX LESS THAN OR EQUAL TO 25 AND SMOKE DEVELOPED INDEX LESS THAN OR EQUAL TO 50.

ALL EXPOSED CORE EDGES MUST BE SEALED WITH APPROPRIATE LOW-E TAPE DO NOT ALLOW ANY FOIL FACED INSULATIONS TO COME INTO CONTACT WITH ANY ELECTRICAL WIRING

CERTIFIED BY INDEPENDENT THIRD PARTY QUALITY CONTROL TESTING AGENCY. MSDS AVAILABLE AS A SEPARATE DOCUMENT

**** NFPA 286 FELL WITHIN ALL 5 SPECIFIED CONDITIONS OF THE TEST AND NO FLASHOVER OCCURED.



Discover even more ways to lower energy costs with ESP LOW-E®



Green building is not just a trend, but the wave of the future as more and more homeowners and builders demand energy efficient homes and products. ESP LOW-E® Insulation products are designed for maximum energy and cost efficiency. Whether it's under slab, under roof, around duct work or wrapping the

entire house, ESP LOW-E® Reflective Insulation saves more money on heating and cooling than regular insulation and housewrap.

Check out all the ways ESP LOW-E® Insulation can help reduce your energy consumption around the home.



REFLECTIVE INSULATION
Reduces your carbon footprint.



For more information on ESP LOW-E® Insulation products and individual specifications contact Environmentally Safe Products, Inc. at 1-800-289-5693, or visit us online at WWW.LOW-E.COM